

ELEVATION VIEW

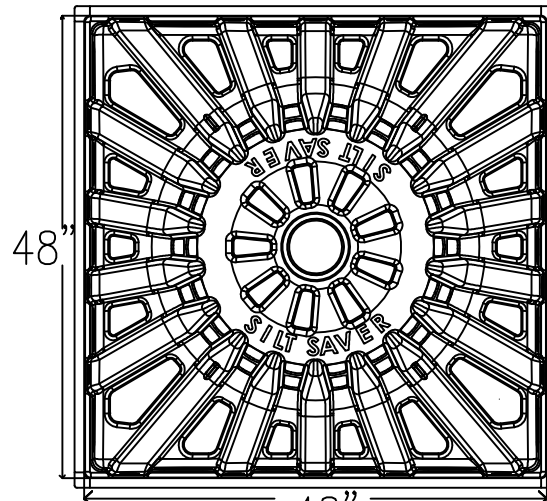

PLAN VIEW

FILTER OPTIONS FOR ASSEMBLIES:

- 1) A1100A-HF: (HIGH-FLOW FILTER) GREEN HIGH FLOW MATERIAL THROUGHOUT THE TOP OF THE FILTER EXTENDING TO ROCK BAG PLATFORM.
- 2) A1100A-DOT: (DOT FILTER) GREEN HIGH FLOW MATERIAL ALLOWS FOR STORM WATER OVERFLOW AT THE TOP OF THE FILTER WHILE THE GRAY HIGH EFFICIENCY SEDIMENT FILTRATION FABRIC COVERS THE BOTTOM HALF OF THE FILTER EXTENDING TO THE ROCK BAG PLATFORM. IT IS THE PURCHASERS RESPONSIBILITY TO SELECT APPROPRIATE FILTER.

FILTER INSTALLATION

FILTER SHOULD BE PLACED OVER FRAME. POCKETS ON THE EDGES OF THE FILTER SHOULD BE FILLED WITH ROCK. INSTALLER SHALL PROVIDE ROCK FOR FILTER POCKETS.

MAINTENANCE

ALL TEMPORARY EROSION, SEDIMENTATION, & POLLUTION CONTROL PRACTICES SHOULD BE INSPECTED DAILY. CONTRACTOR SHALL REMOVE SEDIMENT AND DISPOSE IN A PROPER MANNER. INSPECT FRAME AND FILTER DAILY FOR CUTS, ABRASIONS AND PROPER INSTALLATION. REPLACE OR REPOSITION, AS NECESSARY.

REPLACEMENT FILTER OPTIONS

A1140-DOT, A1140-HF

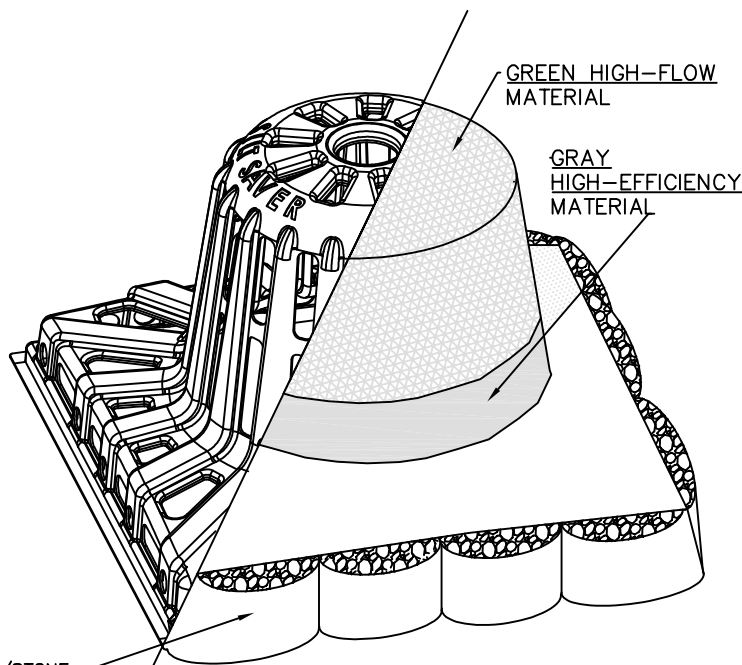

ISOMETRIC ASSEMBLY VIEW OF A1100A-DOT

SQUARE BASE FRAME & FILTER

48"X48"

MODEL# A1100A

FRAME MATERIAL: HMWPE

FILTER FABRIC MATERIAL: REFER TO SPEC

SCALE: NOT TO SCALE

LAST UPDATED: MARCH 2022